

REF	X	Y	Z
MEJ39720	160	160	65
MEJ39721	180	180	65
MEJ39722	140	140	65
MEJ39723	160	160	75
MEJ39721	180	180	75
MEJ39725	140	140	75

Tissot
móveis

MEJ DRINK

LUCIANO SANTELLI

MEJ DRINK

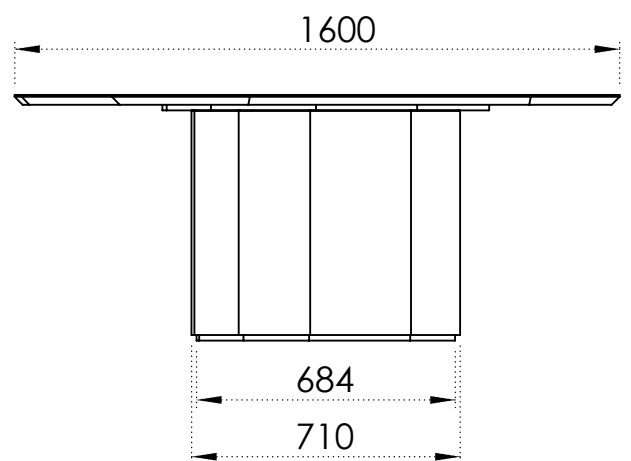
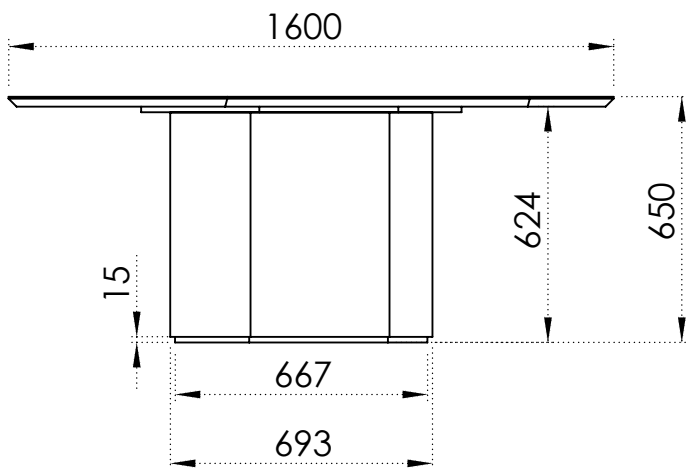

VISTA FRONTAL

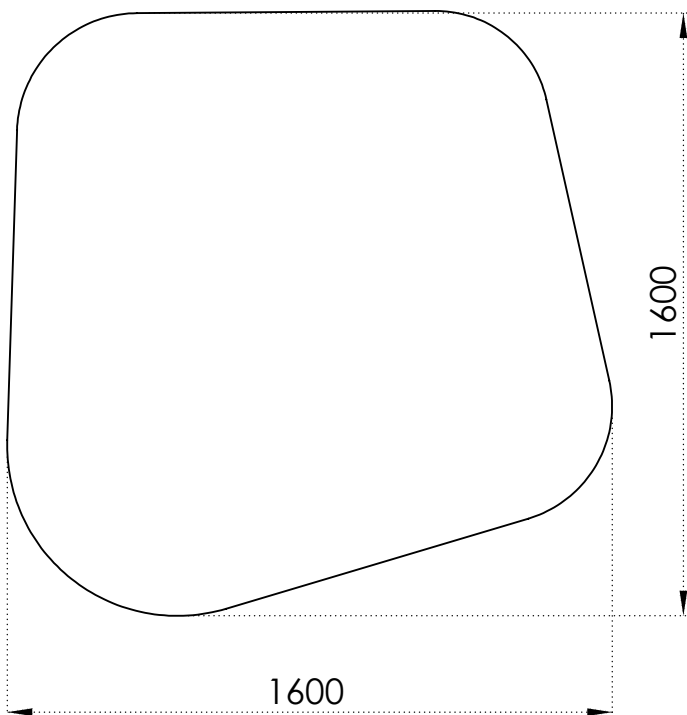

VISTA LATERAL

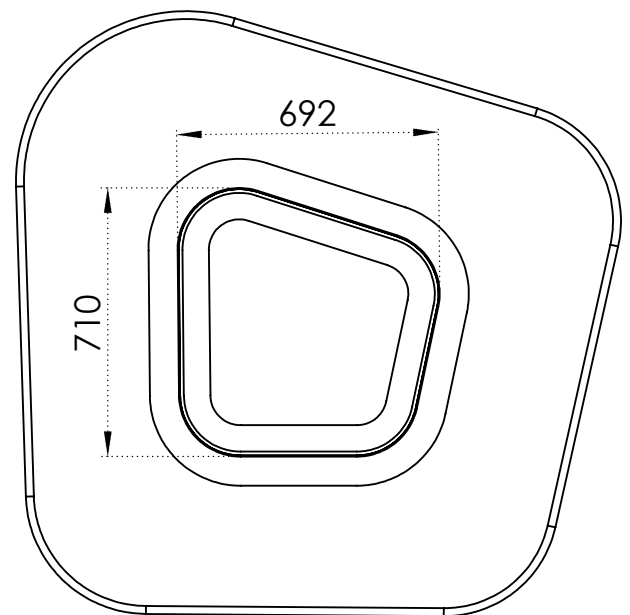

VISTA SUPERIOR

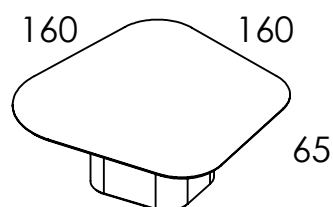

Tissot
móveis

MEJ DRINK

LUCIANO SANTELLI

MEJ39720

20/10/2022

desenho03

TAMPO
1606X1600X26
USINADO

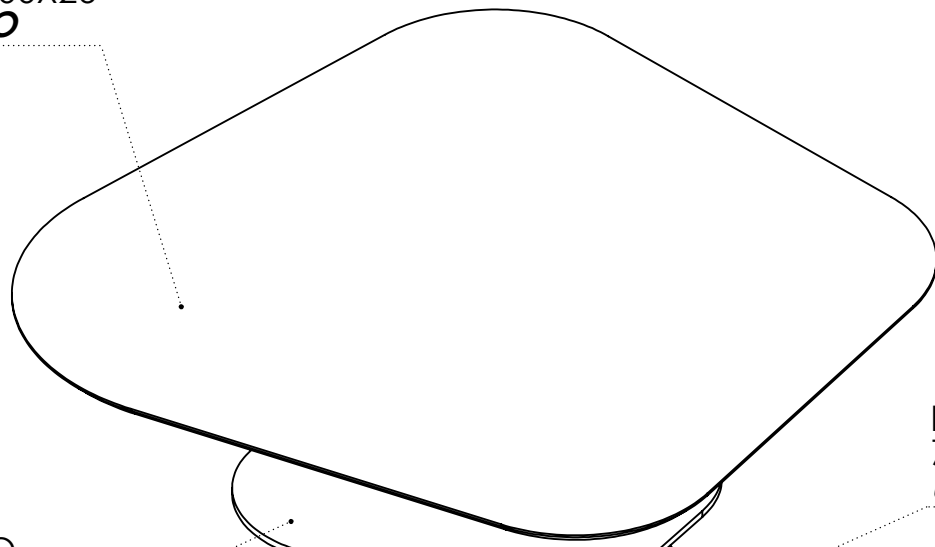

BASE
700X700X15
USINADO

SUBTAMPO
860X860X15
USINADO

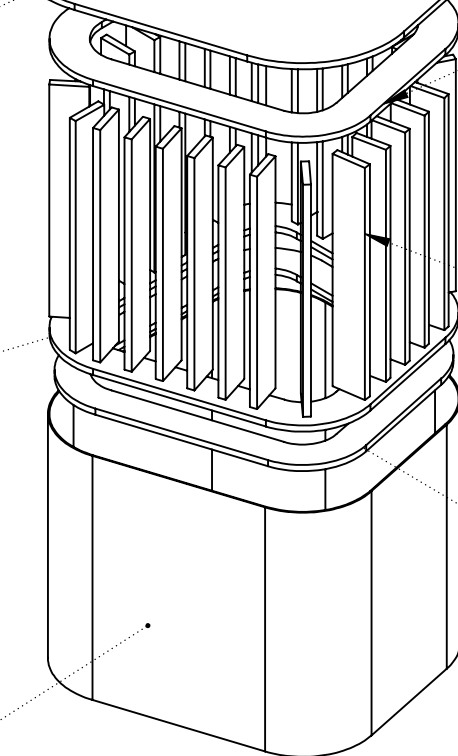

SUPORTE BASE
564X80X16

BASE
700X700X15
USINADO

RODA PÉ BASE
680X680X15
USINADO

CAPA
2393X593X3

Tissot
móveis

MEJ DRINK

LUCIANO SANTELLI

MEJ39720

20/10/2022

desenho03

MDF

Q TOTAL	Q UNIT	DESCRIÇÃO	PRÉ-CORTE	MATERIAL	OBS	DIMENSÃO
TAMPO						
	1	TAMPO	1616X1610X26	Laminado	USINADO	1606X1600X26
	1	SUBTAMPO	870X870X15	MDF Crú		860X860X15
BASE						
	2	BASE	710X710X15	MDF Crú	USINADO	700X700X15
	1	RODA PÉ BASE	690X690X15			680X680X15
	27	SUPORTE BASE				564X80X16
	1	CAPA	2416X593X3	Laminado		2393X593X3

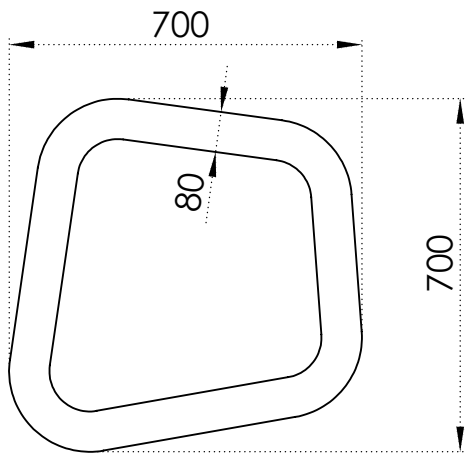

BASE

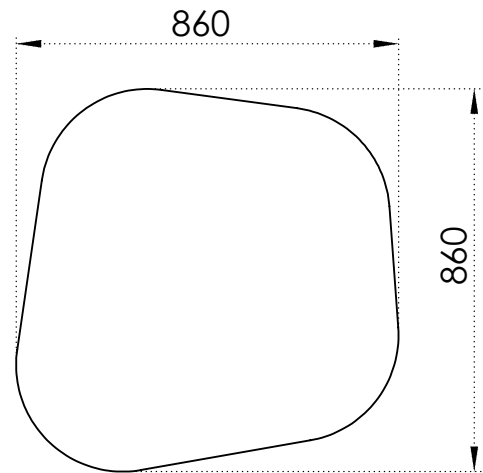

SUBTAMPO

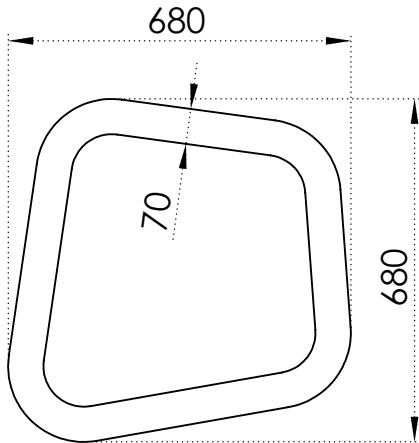

RODA PÉ BASE

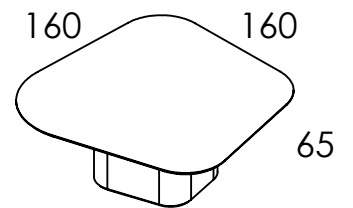

	
MEJ DRINK	
LUCIANO SANTELLI	MEJ39720
20/10/2022	desenho03